

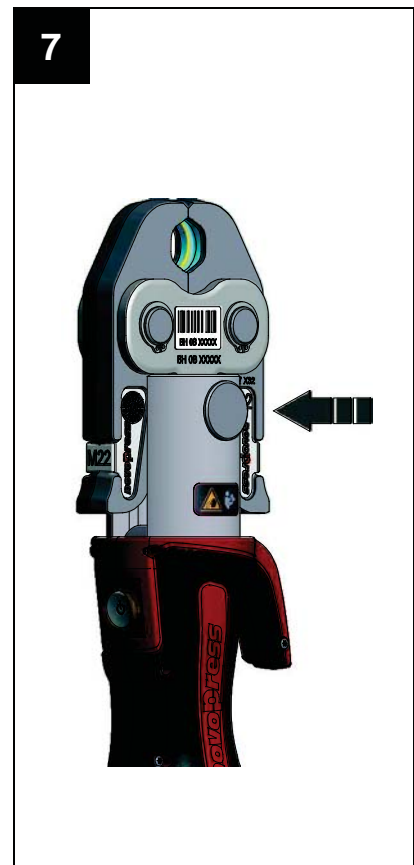

ACO203

EN Operating Manual

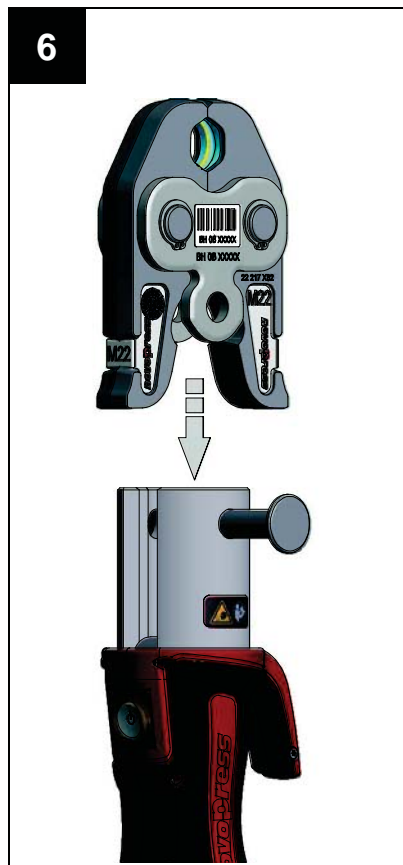

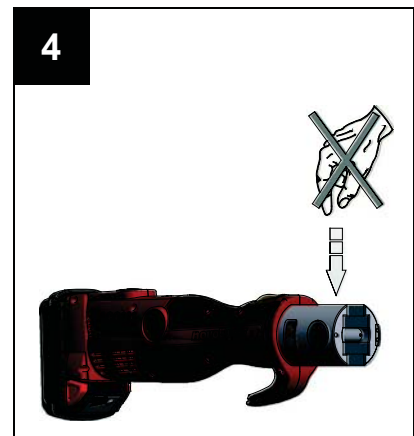
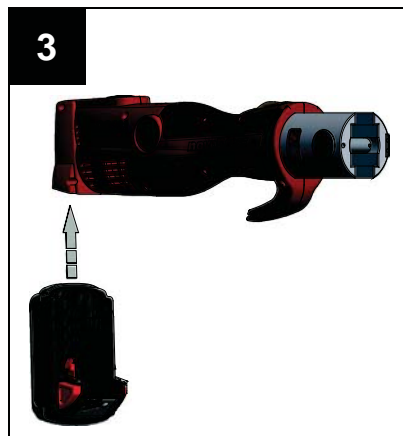
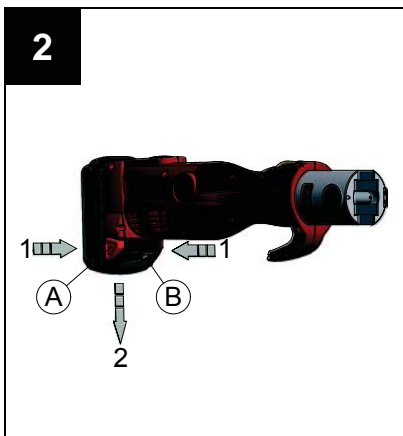
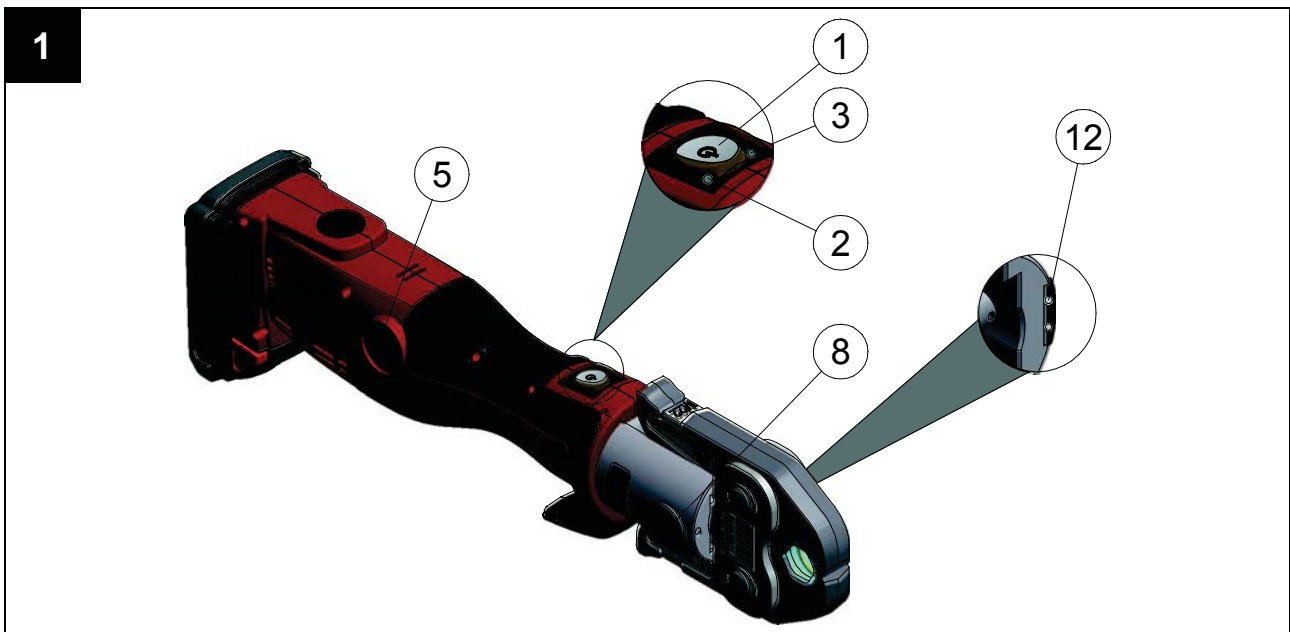
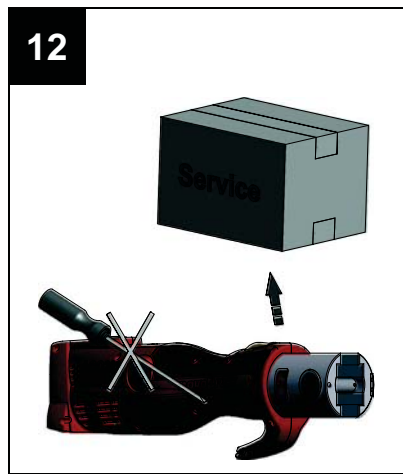
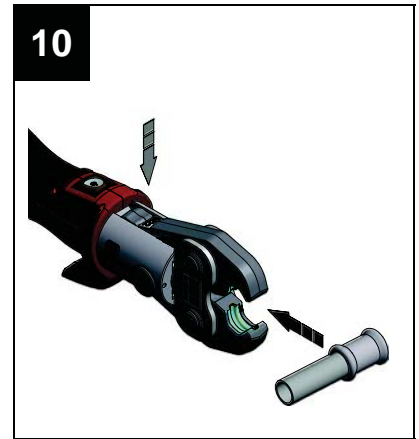
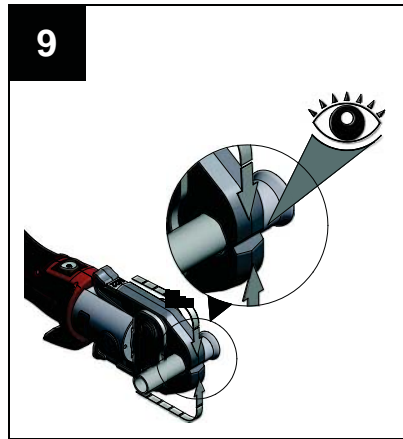
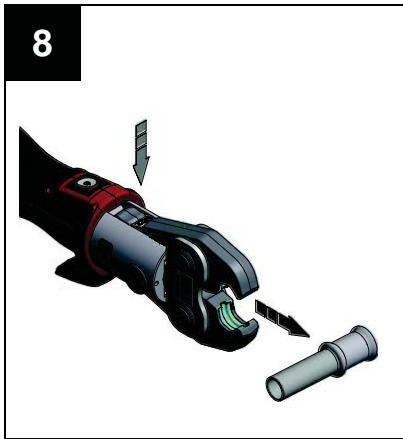

ACO203 / ECO203

EN English

Translation of the Original Instructions

Contents

1	Proper use	11
2	Basic safety information	11
3	Definition of terms.....	13
4	Symbols on the device and information on the rating plate	13
5	Scope of supply	14
6	Technical data	14
7	Brief description of the press device	15
8	Commissioning and operation.....	16
9	Cleaning, maintenance and repair	18
10	Disposal.....	19
11	Warranty and guarantee.....	19
12	EU Declaration of Conformity.....	20

1 Proper use

These press devices are intended exclusively for use with press jaws/adaptor jaws and press collars manufactured by Novopress or approved by Novopress in agreement with the system supplier. For further details, please contact the system supplier or Novopress direct.

The devices, press jaws and press collars are to be used exclusively for the purpose of press-fitting pipes and fittings for which the relevant press jaws and press collars have been designed.

Any use beyond or different to that described here shall be regarded as improper use.

All work with this tool that does not correspond to proper use may lead to damage to the press device, the accessories or the pipes. Leaks and/or injury may result.

Novopress is not liable for damage resulting from

- the use of unsuitable press tools or press tools from other manufacturers, or
- applications that do not conform to proper use.

Proper use also includes compliance with the Operating Manual, adherence to the inspection and maintenance conditions as well as compliance with the latest versions of all relevant safety regulations.

2 Basic safety information





The following pictograms are used to highlight sections of text. Please follow these instructions and act with particular caution in these cases. Pass all health and safety instructions on to other users and technicians.

	<p>WARNING!</p> <p>This information indicates a potentially dangerous situation that could result in serious injury or death.</p>
---	--

	<p>CAUTION!</p> <p>This information indicates a potentially dangerous situation that could result in minor injuries and/or material damage.</p>
---	--

	<p>Information!</p> <p>This information is directly linked to the description of a function or an operating sequence.</p>
---	--

**Please read this Operating Manual carefully.
The safety instructions it contains must be observed.
Compliance with local safety regulations is essential!**

 	<p>WARNING! Read and follow all safety information and instructions. Failure to comply with the safety information and instructions may result in electric shock, fire and/or serious injuries. Therefore:</p> <ul style="list-style-type: none"> – Keep all safety information and instructions for future use and only pass the devices on to others together with the instructions.
	<p>WARNING! Risk of injury from ejected fragments Incorrect or improper use or the use of worn or damaged press tools and press devices carries a risk of injury from ejected fragments. Therefore:</p> <ul style="list-style-type: none"> – Press tools and press devices may only be used by trained personnel. – Compliance with the specified service work and service intervals is mandatory. – Check the press tools and press devices for cracks and other signs of wear before each use. – Separate all press tools and press devices with material cracks or other signs of wear immediately and do not use them any longer. – Only use press tools and press devices that are in perfect technical condition. – Following incorrect use, do not use the press tool and press device any longer and have them inspected by an authorised workshop.
	<p>CAUTION! Unskilled use may lead to a damaged or malfunctioning press tool and press device. Therefore:</p> <ul style="list-style-type: none"> – Replace worn press tools immediately and do not use them any longer. – Use carrying cases for transport and storage and keep press tools and the press device in a dry room. – Have damage checked immediately by an authorised workshop. – Comply with the safety instructions regarding the cleaning and anti-corrosion agents used.
	<p>Information! Consult the documents provided by the system supplier for handling and assembly instructions for fittings and pipes.</p>



3 Definition of terms

V	volt
A	ampere
Hz	hertz
W	watt
kW	kilowatt
g	gram
kg	kilogram
Bj	year of manufacture

Ah	ampere hour
db(A)	decibel (sound pressure)
bar	bar
°C	degree Celsius
kN	kilonewton
a.c.	Alternating current voltage
d.c.	Direct current voltage
F	force

∅	diameter
h	hour
min	minute
s	second
m/s ²	metre divided by square second (acceleration)
Nr	number

4 Symbols on the device and information on the rating plate

Symbol	Meaning
	Warning – ejected fragments
	Service sticker; indicates when the next service is due.

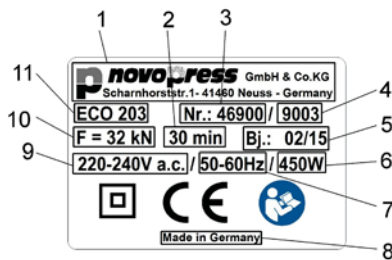

Information on the rating plate





1	Manufacturer logo incl. address
2	Permissible uninterrupted operating time
3	Part No.
4	Serial No.
5	Year of manufacture mm.yy
6	Power consumption

7	Permissible frequency range, if applicable
8	Country of manufacture
9	Permissible voltage range in volt
10	Nominal force
11	Type designation of device

Explanation of possible pictograms on the rating plate

	Verification marking Canada/ USA
	Registration of products on the uniform customs territory.
	Read Operating Manual

	CE conformity marking product safety in Europe
	Protection class II (insulated housing)
	Verification marking Australia

5 Scope of supply

The scope of supply for the standard equipment includes:

ACO203	ECO203
Press device incl. operating manual	Press device incl. operating manual
Battery charger incl. operating instructions	
Battery 18 V d.c.	
Safety instructions	Safety instructions
Carrying case	Carrying case

Optional additional accessories (e.g. press jaws, adaptor jaws, press collars) may also be included. Please contact the system supplier for information on the scope of supply.

6 Technical data

Device:	ACO203	ECO203
Rated voltage/battery:	18 V d.c. (lithium-ion) 1,5 Ah / 3,0 Ah	see rating plate
Frequency:	--	see rating plate
Power consumption	450 W	see rating plate
Nominal force:	32 kN	32 kN
Height:	111 mm	113 mm
Length:	387 mm with battery 1,5 Ah 407 mm with battery 3,0 Ah	397 mm
Width:	75 mm	75 mm
Net weight:	2,8 kg (with battery)	3,2 kg
Compression range:	Plastic: up to Ø 110 mm Metal: up to Ø 54 mm (up to Ø 108 mm dep. on system)	Plastic: up to Ø 110 mm Metal: up to Ø 54 mm (up to Ø 108 mm dep. on system)
Max. noise level:	87,5 db(A) ¹⁾	89,5 db(A) ¹⁾
Noise pressure level at user's ear:	76,5 db(A) ¹⁾	78,5 db(A) ¹⁾
Vibration value:	<2,5 m/s ² ²⁾	<2,5 m/s ² ²⁾
Type of protection:	IP20	IP20
Protection class:		II
Operating mode:		S3 – 40%
Temperature range during operation:	-10°C to +50°C	-10°C to +50°C

1) Measurement uncertainty 3 db(A)

2)

Measurement uncertainty 1.5 m/s²

The vibration emission value may differ from the stated value while the device is actually in use, depending upon the manner in which the device is used. It may be necessary to establish safety measures to protect operating personnel, depending on the actual conditions of use (intermittent operation).

Caution The vibration emission value may differ from the stated value while the device is actually in use, depending upon the manner in which the device is used. It may be necessary to establish safety measures to protect operating personnel, depending on the actual conditions of use (intermittent operation).

Battery charger

For information on the function and operation of the battery charger and the rechargeable batteries, please consult the battery charger operating instructions.

7 Brief description of the press device

7.1 Automatic press cycle (Fig. 1)

The device features an automatic press cycle. This ensures that the pressing operation is always completed. The automatic press cycle is activated after approx. 1.5 seconds. After the automatic press cycle has been triggered, the green LED (2) goes out and the pressing operation runs automatically. The pressing operation can then only be stopped by pressing and holding release button (5). After the pressing operation has been completed, the motor automatically switches off and the green LED (2) lights up again.

If the start button (1) is released before the automatic press cycle begins, the piston in the press device moves back to its starting position. The pressing operation will not have been completed. The pressing operation must be triggered again.

7.2 Release button (Fig. 1)

The pressing operation can be stopped at any time by pressing and holding the release button (5). The piston in the press device then returns to its starting position.

7.3 Pressing point lighting

When the start button (1) is pressed, the pressing point is lit by 2 LEDs (12). If the press device is out of use for approx. 30 seconds, the device and the LEDs switch off.

7.4 Battery (ACO203 only)

	<p>Information!</p> <p>The batteries are not charged at the factory.</p> <p>Therefore:</p> <ul style="list-style-type: none"> – Charge the batteries before using for the first time.
---	---

	<p>Information!</p> <p>Limited temperature range for charging and storing the batteries.</p> <p>Therefore:</p> <ul style="list-style-type: none"> – It is imperative that the operating instructions for the battery charger are complied with.
---	---

Removing the battery (Fig. 2)

Push in (1) the two release buttons (A) and then remove the battery (2).

Inserting the battery (Fig. 3)

Slide the battery into the device as illustrated until it clicks into place.

Battery charge indicator (Fig. 2)

The battery charge is displayed when button (B) is pressed. The number of LEDs lit up denotes the battery charge. One flashing LED indicates a maximum power reserve of 10%. The battery must be charged soon.

If the battery is inserted in the press device while the battery charge is being checked, the last pressing operation must have been completed at least 1 minute prior to this. Otherwise the display will be inaccurate.

7.5 ACO203 and battery



Information!

The ACO203 press device must only be operated with 18 V lithium-ion rechargeable batteries. The 18 V battery must only be used in the appropriate press devices.

Feature of the press device after extended periods out of use or when changing the battery:

If the press device is out of use for approx. 30 seconds or the battery is reinserted, it switches off. No LED is lit up any longer. Press the start button (1) briefly to start the press device.

Feature of the press device when the battery is empty:

When a pressing operation begins, a check is made to determine whether the battery charge is sufficient to complete the pressing operation. If this is not the case the device does not start. The green LED (2) flashes.

If the green LED (2) flashes following a pressing operation, the pressing operation was carried out correctly. The battery must be recharged prior to the next pressing operation.

8 Commissioning and operation

8.1 Preparing the ACO203 / ECO203



CAUTION!

Fingers risk being crushed if the device is operated without a press jaw/adaptor jaw (Fig. 4)

If no press jaw/adaptor jaw is fitted, fingers could be placed in the at-risk zone. Fingers could be crushed when the device is started.

Therefore:

- Do not operate the device without press jaws.
- Keep your fingers away from the at-risk zone.



Information!

The device will not start if the retaining pin (8) is incorrectly inserted. The green LED flashes.



Information!

The press device is not suitable for continuous operation. Following 30 minutes of continuous operation, a short break of at least 15 minutes must be taken to allow the device to cool down.

- Insert the press jaw/adaptor jaw into the press device as shown in Fig. 5 to 7.

8.2 Meaning of the LED display

LED display	Status/cause	Measure
Green LED (2) off.	Device is switched off.	Briefly press the start button (1) (see section 7.5).
Green LED (2) lights up.	On standby.	
Green LED (2) off (pressing operation in progress).	Automatic press cycle is on, device ends the pressing operation automatically.	
Green LED (2) flashes.	Insufficient battery charge.	Charge or replace battery.
Green LED (2) flashes.	Retaining pin not correctly shut.	Insert retaining pin, or check retaining pin and cylinder.
Green LED flashes. (Press device automatically returns to initial position.)	Retaining pin has come loose!	Insert retaining pin, or check retaining pin and cylinder. NOTE The pressing operation may not have been completed; please check and repeat if necessary.
Red LED (3) flashes.	Device not within the temperature range.	The device only works within a temperature range from -10 to +50°C. If the red LED is flashing, the device must be moved into a warmer or colder area. The device can be warmed to operating temperature by means of dry runs.
Red LED (3) lights up.	Device fault.	Press the start button (1). If this is unsuccessful, the press device is defective. Send the device to a specialist workshop. NOTE! The pressing operation may not have been completed; please check and repeat if required.

8.3 Performing the pressing operation

	<p>CAUTION! Danger of crushing!</p> <p>There is a risk that fingers and hands will be crushed. Therefore:</p> <ul style="list-style-type: none"> – Keep body parts and foreign objects away from the press jaws during the pressing operation. – Do not hold the jaw levers with your hands during the pressing operation.
---	--

	<p>CAUTION! Keep fingers away from the at-risk zone if no press jaw/adaptor jaw is fitted. (Fig. 4)</p> <p>Fingers risk being crushed. Therefore:</p> <ul style="list-style-type: none"> – Do not operate the device without the jaws. – Keep your fingers away from the at-risk zone.
---	--

	<p>Information!</p> <p>The device will not start if the retaining pin (8) is incorrectly inserted. The green LED flashes.</p>
---	--

	<p>Information!</p> <p>Always comply with the operating instructions for the press tools!</p>
---	--

1. Check whether the nominal width of the press fitting matches the nominal width of the press jaw/press collar.
2. Comply with the system manufacturer's instructions when fitting the press jaw/press collar (Fig. 8).
If using a press collar: Fit the adaptor jaw to the press collar as described in the press collar manufacturer's instructions.

	<p>Information!</p> <p>Make sure that the press jaw is fully closed when pressing is complete (Fig. 9).</p>
---	---

	<p>Information!</p> <p>Ensure there is no gap between the segments of the press collar when the pressing operation is complete.</p>
---	---

3. To start the process, press the start button.
4. When pressing is complete:
 - If using a press collar: First detach the adaptor jaw from the press collar, then
 - Detach the press jaw/press collar from the press fitting (Fig. 10).

9 Cleaning, maintenance and repair

	<p>CAUTION!</p> <p>Risk of injury during cleaning or repair work from inadvertently pressing the On switch.</p> <p>Therefore:</p> <ul style="list-style-type: none"> – Comply with the safety instructions and always remove the battery or disconnect the mains plug before performing cleaning, maintenance or repair work.
---	--

Service addresses

Novopress GmbH & Co. KG
Scharnhorststr. 1
41460 Neuss
Germany

You can find the addresses of authorised specialist workshops by contacting Novopress or at www.novopress.de.

Service intervals

Service and repair work may only be carried out by Novopress or the authorised Novopress specialist workshops.

	<p>Information!</p> <p>The next service deadline is indicated on the press device. This service must be performed at least every 2 years.</p>
---	--

Routine inspection (before use, at the start of the working day) and when soiled (Fig. 11)

Check for visible damage, material cracks and other signs of wear. If defects are found, do not use the device and have it repaired.

Six-monthly inspection

Have the device inspected by a qualified electrician or a Novopress workshop

Annually to get a 1-year extended warranty (see section 11 Warranty and guarantee)

Have the press device inspected and serviced at Novopress or a Novopress workshop.

10 Disposal

	<p>CAUTION! Groundwater hazard The device contains hydraulic fluid.</p> <p>Hydraulic fluids pose a hazard to groundwater. Uncontrolled drainage or improper disposal is punishable by law.</p> <p>Therefore:</p> <ul style="list-style-type: none">– Dispose of the device in an environmentally responsible manner.
---	---

The instructions in the operating instructions provided with the battery charger must be complied with when disposing of rechargeable batteries and the charger.

The product must not be disposed of as normal household waste.

Novopress recommends that disposal be carried out by authorised specialist companies.

Alternatively, waste devices can be returned directly to Novopress (or a specialist workshop) for proper disposal.

11 Warranty and guarantee

Novopress provides the full statutory warranty of 24 months for its press devices and tools. The warranty period always commences on the date of delivery, which must be proven by means of the sales documentation in case of doubt.

Within the warranty period, the warranty covers the repair of any damage or malfunction of these tools that is attributable to material or production faults.

The following are not covered by the warranty:

- Damage caused by improper use or inadequate servicing.
- Damage caused by the use of products not approved by Novopress for use with its press devices.
- Damage caused by pressing unsuitable pipes or fittings.

For wearing parts, the Novopress warranty lasts only for the intended service life.

Service work and parts provided in response to warranty claims do not have to be paid for. However, all shipping costs shall be borne by the user.

Claims can only be accepted if the device is delivered to Novopress or a Novopress workshop in an assembled state.

Repair or replacement of the device under warranty does not result in an extension of the warranty period. Repair or replacement can only be performed using as-new components, the function of which corresponds to that of the old components. All parts that are faulty and consequently replaced are the property of the manufacturer.

Extended warranty on expiry of the statutory warranty period

We voluntarily provide the following extended warranties beyond the statutory warranty period

1-year extended warranty for new press devices, adaptor jaws and press collar

Novopress provides an extended warranty of one year for all new press devices, adaptor jaws and press collars that have been serviced at least every 12 months by Novopress or by an authorised Novopress workshop. There is a charge for this service work. For details of costs, please contact Novopress or an authorised Novopress workshop.

3-year extended warranty for new press jaws

Novopress provides an extended warranty of three years for all new press jaws, interchangeable jaws and press inserts that have been serviced at least every 12 months by Novopress or by an authorised

Novopress workshop. There is a charge for this service work. For details of costs, please contact Novopress or an authorised Novopress workshop.

Repair warranty

Novopress provides the following repair and spare parts warranty beyond the warranty period for new products that undergo repair after this period:

- 6-month warranty for replaced spare parts.
- 12-month warranty for replaced assemblies.
- 12-month warranty for replaced press devices.

12 EU Declaration of Conformity

in accordance with EU Directives 2004/108/EC; 2006/42/EC

We hereby declare that the design, construction and version sold by us of the

ACO203 and ECO203 press devices

conform to the relevant, fundamental health and safety requirements. If the relevant product is not used in accordance with proper use or in the event of a modification to the product not agreed by us, this declaration shall become null and void..

Applicable standards:

EN 55014-1; EN 55014-2; EN 60745-1; EN ISO 12100

A handwritten signature in black ink, appearing to read 'S. Meyer'.

Novopress GmbH & Co. KG
Scharnhorststr. 1
41460 Neuss
Germany

Sven Meyer
Managing Director
02.03.2015

Repairs / Service

novopress

Scharnhorststr. 1
41460 Neuss
Germany

Postfach 101163
41411 Neuss
Germany
Tel: +49 (2131) 2880
Fax: +49 (2131) 28855
www.novopress.de
E-mail: info@novopress.de