



AusPress®

IPS 316



Developed specifically to suit existing imperial pipe sized systems with the installation advantages of press-fit.



profile



1/2" to 2" IPS
Imperial Pipe Sizes

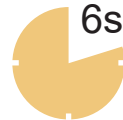

Press a 3/4"mm fitting onto the stainless tube in under 6 seconds. Join done.

Faster to Install

Blucher Press-Fit offers large time savings compared to welding, threading, grooving or glueing.

Safer to Use

- We train your team onsite.
- One button tool operation.
- Lightweight battery tools.
- No flames or hot work permits.
- No heavy gas tanks.
- No hazardous fumes.
- Less risk.

Experience Counts

- We were the first to supply press-fit stainless in Australia & New Zealand.
- We work with consultants & installers on specialised complex projects regularly.

Quality to Install

- Approved to Australian & International standards.
- **Material traced from coil to fittings (3.1 certs).**
- Same diameters to match imperial pipe size tube.

Reliable Design

- Suits a wide range of applications.
- Permanent high strength with the original 'M' press join profile.
- Consistent low profile join look & quality each time.

Environmental Choice

- Long service life.
- Closed loop material (completely recycled to make more stainless).
- Efficient and waste free install.
- Green Star project experience.

Installing Press-Fit

We offer hire, purchasing and servicing for our Press Tools.

Start to install quicker...

Blucher Press-Fit is installed easily & quickly using a Press Tool to form a permanent 'M' profile pressed joint between pipe and fitting.



Start here

Check for suitability...

Both the piping material (eg 316 stainless steel) and the elastomer (eg rubber ring seal) must be checked if suitable for the possible fluids and exterior environments.

If in doubt, ask us!

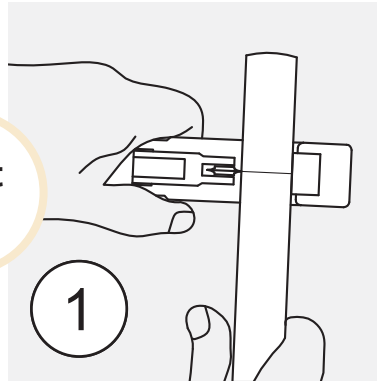

Cut to Length

Cut the pipe at right angles using a tube cutter or fine tooth saw.

Note: Using the same cutting tool on different metals can lead to corrosion (eg steel then stainless).

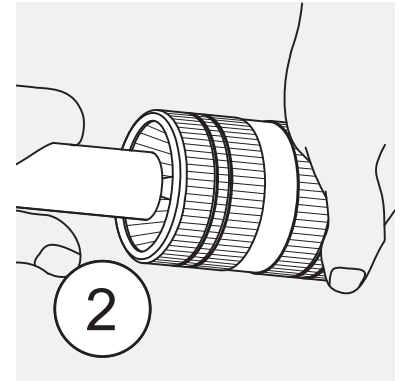

Deburr Pipe

Deburr both inside & outside edges of pipe to prevent damage to the ring seal of the fitting.

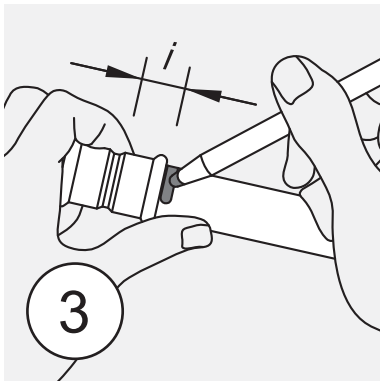

Mark the Insertion Depth "I"

Measure or use a depth gauge to mark the insertion depth (socket depth) onto the pipe end.

This is a visual quality control mark to ensure the pipe is fully inserted.

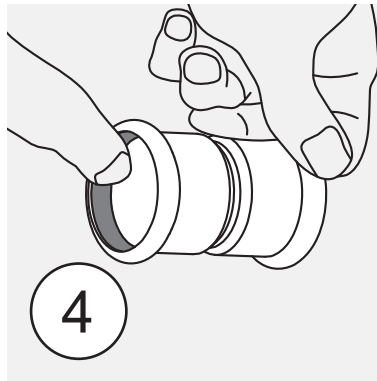

Inspect Fitting & Ring Seals

Check that the rubber ring seal is:

- The correct material type (colour) of seal is used.
- The seal is not damaged.
- Both fitting & seal are free of debris.

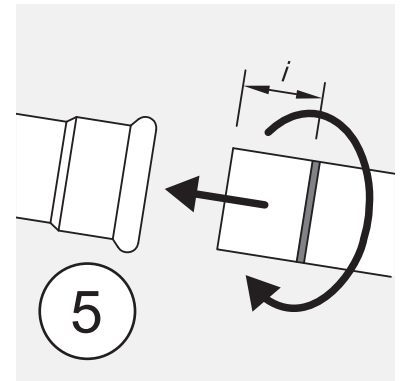

Join the Pipe & Fitting

Insert the pipe into the fitting press socket, turning slightly until it reaches the previously marked insertion depth.

Soapy water can be used if joining is difficult.

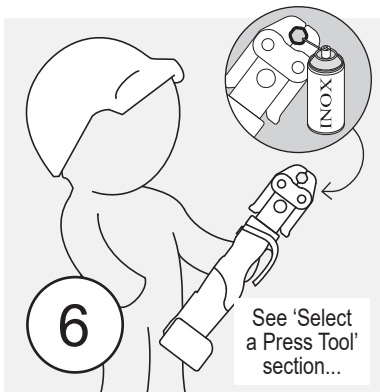

Press Tool Selection

Select the correct press tool, jaw or collar to suit the fitting, dimension and application pressures. Ensure press zone is lubricated each press with Inox spray.



Press the Join

Open the press tool jaw, align with the press socket and start the Press Tool to join the fitting & pipe.

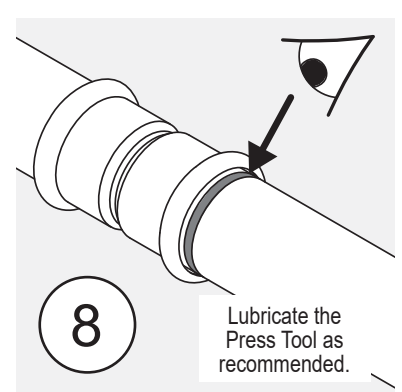

Check & Complete

Visually inspect the pressed fitting & that the insertion mark is aligned with the end of the socket.



Select a Press Tool

Read with 'Press-Fit Technical' section.

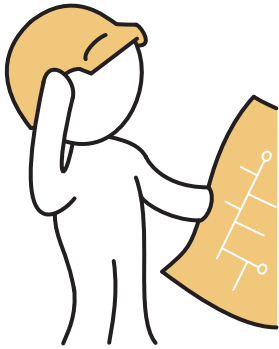

The right tool for the job...

Our fleet of tools are designed to install Blucher Press-Fit quickly & consistently without the need for welding or threading to form a permanent join.

Our trained Sales Executives can meet onsite for Press Tool training to meet your OH&S requirements and we maintain records of attendees.

Start here



IPS Press-Fit Press fittings onto either Sch5s or Sch10s imperial pipe.

1/2" - 1" IPS

IPS



IPS Press Jaw

1 1/2" & 2" IPS

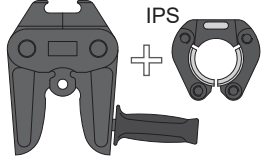

ZB221 Adaptor Jaw & IPS Collar

Max Press-Fit Working Pressure for completed pipework system*:

25 bar 362 psi

Subject to applicable approval and regulation maximum pressures.

25 bar 362 psi

Press Tool Options:

AFP202



6 sec press

ACO203



ACO203-XL



The 'M' Profile Press...
Blucher Press-Tools are calibrated to suit our products and although they may look similar to others, the tolerances of the systems are different.

Our tooling recognises the difference and does not complete a full press. Any warranty or similar is void as a result.

Please Note:
This chart is a guide and full specifications and instructions are available on request.

* This value is the Maximum Working Pressure, not the safety or testing pressure of the system. Maximum also depends on the application - check with us first.

Joint Log Book:
For project QA

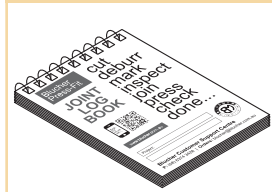

Now available

Need to convert units?

1 bar ≈ 100 kPa
1 bar ≈ 14.5 psi

25 bar ≈ 362 psi
25 bar ≈ 2500 kPa

AusPress® Press-Fit
IPS 316

Installation Tools

These items make installing Blucher Press-Fit easier.

Remember using the same cutting or deburring tool on different metals can lead to corrosion (eg cut steel then cut stainless steel).

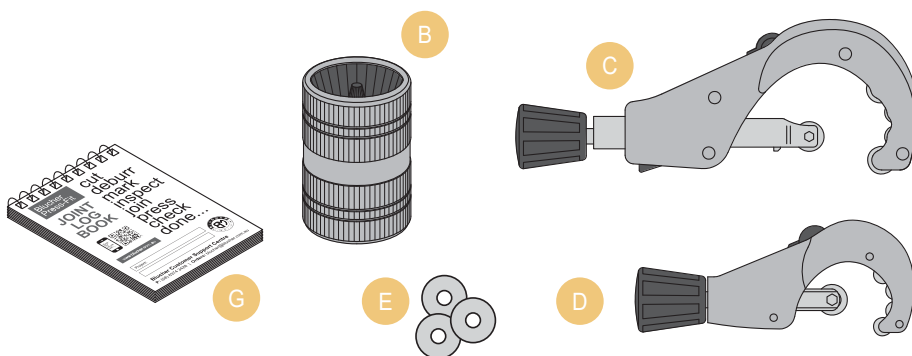

Press Tools:

Information and capacities are listed under "Select a Press Tool" Section.

Image	Suits...	Product No	
B	Manual Deburrer	1/2" - 2"	VT.DEB
C	Manual Tube Cutter 'Rat'	1/2" - 3"	VT.TCUT.006.076
D	Manual Tube Cutter 'Rat'	1/4" - 1.1/2"	VT.TCUT.003.045
E	Replacement Cutting Wheel for 'C & D' (each)		VT.TCUT.WHEEL
G	Blucher Press-Fit Joint Log Book & Cover		BA.BM007-06



What Stainless Grade Imperial Pipe should I use?

Blucher Press-Fit IPS fittings are supplied only in Schedule 5, 316 stainless steel but are compatible with either 304 or 316 stainless imperial Schedule 5 or 10 pipe.

Refer to our Technical Data Sheets for material suitability and resistance.

The choice of stainless grade is dependant on many factors and must be investigated with water sample analysis or technical advice to confirm suitability.

Please ask us if you require more information or technical advice for your project.

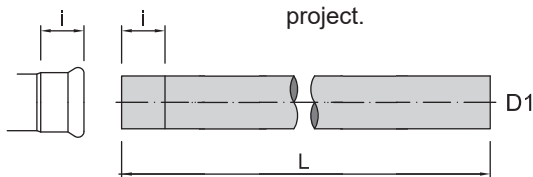

i = insertion depth. Pipe must be inserted into the press socket a minimum distance to ensure the joint is pressed successfully.

D1 (inch)	OD (mm)	i depth	NB (mm)	t S5 Wall	t S10 Wall
1/2"	21.34	21	15	1.65	2.11
3/4"	26.67	24	20	1.65	2.11
1"	33.40	26	25	1.65	2.11
1 1/2"	48.26	30	40	1.65	2.11
2"	60.33	45	50	1.65	2.11

For technical information for specialised projects please ask us. We've over 20 years experience, have access to testing metallurgist services too.

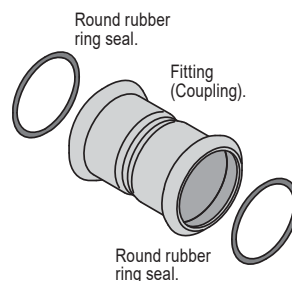

Rubber Ring Seals

Depending on the application, the ring seals may need to be changed to a different type for higher chemical or temperature resistance.

More info in the ring seal product listing.

IPS Coupling Socket - Socket

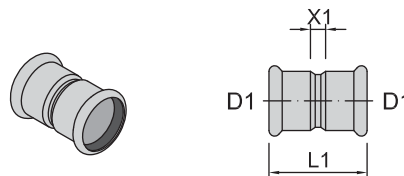

Material: 316 stainless steel.

Ring Seal: EPDM x2 supplied.

Product No	D1	L1	X1
IPS.507.15	1/2"	53	11
IPS.507.20	3/4"	59	11
IPS.507.25	1"	63	11
IPS.507.40	1 1/2"	72	11
IPS.507.50	2"	103	13

IPS Slip Coupling Socket - Socket

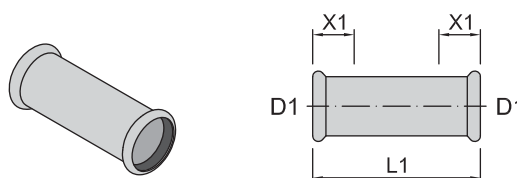

Material: 316 stainless steel.

Ring Seal: EPDM x2 supplied.

Product No	D1	L1	X1
IPS.508.15	1/2"	75	21
IPS.508.20	3/4"	86	24
IPS.508.25	1"	97	26
IPS.508.40	1 1/2"	122	30
IPS.508.50	2"	172	45

■ IPS Spigot Reducer Pipe End - Socket

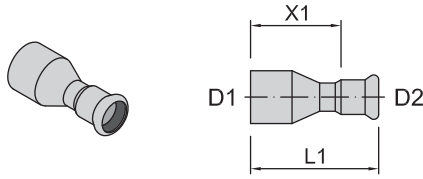

Material: 316 stainless steel.

Ring Seal: EPDM x1 supplied.

Product No	D1	D2	L1	X1
IPS.583.20.15	3/4"	1/2"	77	31
IPS.583.25.15	1"	1/2"	110	66
IPS.583.25.20	1"	3/4"	96	44
IPS.583.40.15	1 1/2"	1/2"	87	29
IPS.583.40.20	1 1/2"	3/4"	90	41
IPS.583.40.25	1 1/2"	1"	90	33
IPS.583.50.15	2"	1/2"	107	41
IPS.583.50.20	2"	3/4"	110	40
IPS.583.50.25	2"	1"	111	39
IPS.583.50.40	2"	1 1/2"	135	67

■ IPS Tee Equal Socket Ends & Branch

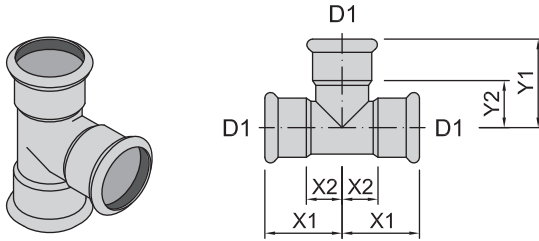

Material: 316 stainless steel.

Ring Seal: EPDM x3 supplied.

Product No	D1	BR	X1	X2	Y1	Y2
IPS.572.15	1/2"	1/2"	38	16	42	20
IPS.572.20	3/4"	3/4"	43	19	47	23
IPS.572.25	1"	1"	49	23	53	27
IPS.572.40	1 1/2"	1 1/2"	61	30	65	35
IPS.572.50	2"	2"	86	41	86	41

■ IPS Tee Reduced Socket Ends & Branch

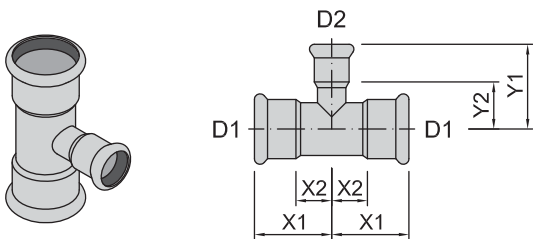

Material: 316 stainless steel.

Ring Seal: EPDM x3 supplied.

Product No	D1	BR	X1	X2	Y1	Y2
IPS.573.20.15	3/4"	1/2"	43	19	44	23
IPS.573.25.15	1"	1/2"	49	23	48	27
IPS.573.25.20	1"	3/4"	49	23	51	27
IPS.573.40.15	1 1/2"	1/2"	61	30	56	34
IPS.573.40.20	1 1/2"	3/4"	61	30	59	35
IPS.573.40.25	1 1/2"	1"	61	30	61	35
IPS.573.50.15	2"	1/2"	86	41	62	41
IPS.573.50.20	2"	3/4"	86	41	65	41
IPS.573.50.25	2"	1"	86	41	67	41
IPS.573.50.40	2"	1 1/2"	86	41	72	41

■ IPS FI Tee Socket Ends - FI BSP Branch

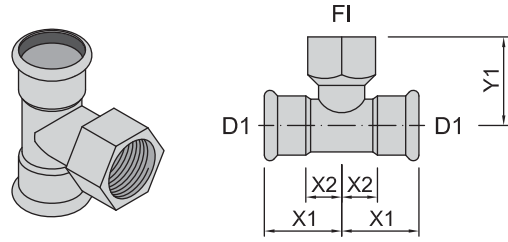

Material: 316 stainless steel.

Ring Seal: EPDM x2 supplied.

Product No	D1	FI	X1	X2	Y1
IPS.578.15.15	1/2"	1/2"	38	16	39
IPS.578.15.20	1/2"	3/4"	38	16	47
IPS.578.20.15	3/4"	1/2"	43	19	41
IPS.578.20.20	3/4"	3/4"	43	19	46
IPS.578.20.25	3/4"	1"	43	19	50
IPS.578.25.15	1"	1/2"	49	23	45
IPS.578.25.20	1"	3/4"	49	23	50
IPS.578.40.15	1 1/2"	1/2"	49	23	53
IPS.578.40.20	1 1/2"	3/4"	61	30	57
IPS.578.40.25	1 1/2"	1"	61	30	58
IPS.578.40.40	1 1/2"	1 1/2"	61	30	66
IPS.578.50.15	2"	1/2"	86	41	59
IPS.578.50.20	2"	3/4"	86	41	64
IPS.578.50.25	2"	1"	86	41	64
IPS.578.50.50	2"	2"	86	41	81

■ IPS Ring Seals

Fittings with a press-fit socket are fitted with an EPDM rubber ring seal as standard.

Depending on the media, this ring seal should be changed to a different rubber material to suit the application.

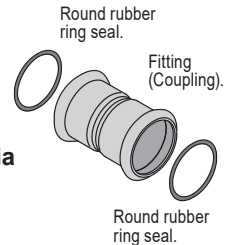

Refer to the relevant Technical Media Chart for the material suitability or contact us for more information.

Type:	Pre-fitted in fitting socket EPDM Standard	Optional extra FKM (Viton) High Temp
	Black -20°C to +110°C	Red or Green -20°C to +200°C
D1	Product No	Product No
1/2"	IPS.EPDM.15	IPS.FKM.15
3/4"	IPS.EPDM.20	IPS.FKM.20
1"	IPS.EPDM.25	IPS.FKM.25
1 1/2"	IPS.EPDM.40	IPS.FKM.40
2"	IPS.EPDM.50	IPS.FKM.50

Refer to our Technical Data Sheets for ring seal suitability and resistance.

IPS 90 Bend Socket - Socket

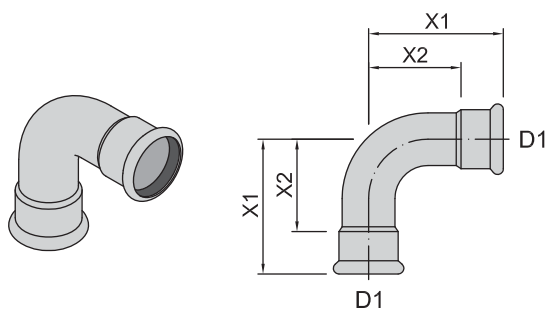

Material: 316 stainless steel.

Ring Seal: EPDM x2 supplied.

Product No	D1	X1	X2
IPS.568.15	1/2"	61	40
IPS.568.20	3/4"	72	48
IPS.568.25	1"	86	60
IPS.568.40	1 1/2"	94	63
IPS.568.50	2"	127	82

IPS 90 Bend Socket - Pipe End

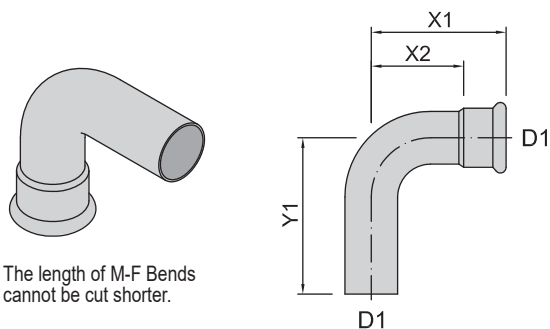

Material: 316 stainless steel.

Ring Seal: EPDM x1 supplied.

Product No	D1	X1	X2	Y1
IPS.303.15	1/2"	61	40	73
IPS.303.20	3/4"	72	48	83
IPS.303.25	1"	86	60	97
IPS.303.40	1 1/2"	94	63	103
IPS.303.50	2"	127	82	140

IPS FI Adaptor Socket - FI BSP

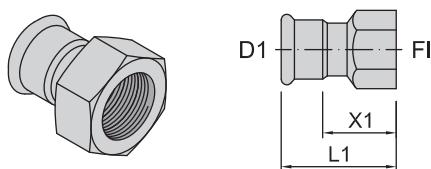

Material: 316 stainless steel.

Ring Seal: EPDM x1 supplied.

Product No	D1	FI	L1	X1
IPS.579.15.20	1/2"	3/4"	62	41
IPS.579.15.25	1/2"	1"	65	44
IPS.579.20.20	3/4"	3/4"	62	38
IPS.579.20.25	3/4"	1"	66	42
IPS.579.25.25	1"	1"	65	39
IPS.579.25.40	1"	1 1/2"	80	54
IPS.579.40.40	1 1/2"	1 1/2"	77	47
IPS.579.40.50	1 1/2"	2"	93	62
IPS.579.50.40	2"	1 1/2"	99	54
IPS.579.50.50	2"	2"	100	55

Are you using the correct type of ring seal?

IPS 45 Bend Socket - Socket

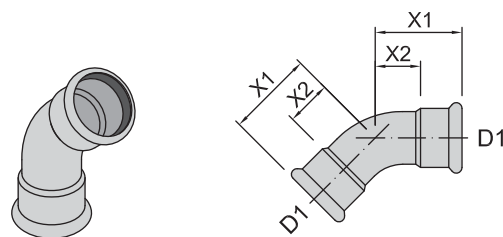

Material: 316 stainless steel.

Ring Seal: EPDM x2 supplied.

Product No	D1	X1	X2
IPS.571.15	1/2"	41	20
IPS.571.20	3/4"	47	23
IPS.571.25	1"	54	29
IPS.571.40	1 1/2"	60	30
IPS.571.50	2"	82	38

IPS 45 Bend Socket - Pipe End

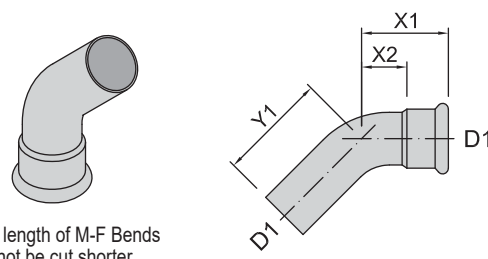

Material: 316 stainless steel.

Ring Seal: EPDM x1 supplied.

Product No	D1	X1	X2	Y1
IPS.307.15	1/2"	40	20	46
IPS.307.20	3/4"	47	23	51
IPS.307.25	1"	54	29	69
IPS.307.40	1 1/2"	60	30	73
IPS.307.50	2"	82	38	91

IPS MI Adaptor Socket - FI BSP

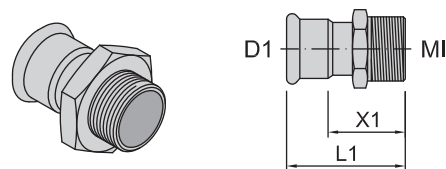

Material: 316 stainless steel.

Ring Seal: EPDM x1 supplied.

Product No	D1	MI	L1	X1
IPS.576.15.15	1/2"	1/2"	56	35
IPS.576.15.20	1/2"	3/4"	58	37
IPS.576.15.25	1/2"	1"	62	41
IPS.576.20.20	3/4"	3/4"	62	38
IPS.576.20.25	3/4"	1"	65	41
IPS.576.25.25	1"	1"	67	41
IPS.576.25.40	1"	1 1/2"	70	44
IPS.576.40.40	1 1/2"	1 1/2"	74	44
IPS.576.50.40	2"	1 1/2"	93	43
IPS.576.50.50	2"	2"	93	43

IPS Adaptor Flange Socket End

This item are available on request in a range of different flange types including ANSI.

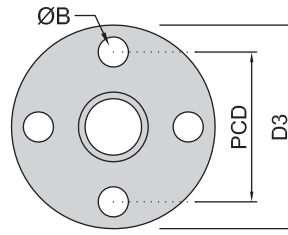
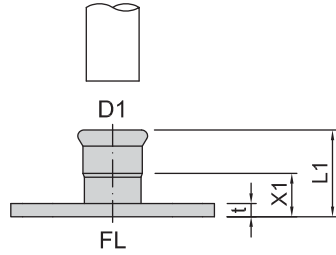
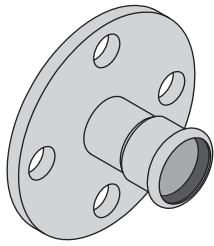

Flanges are welded internally & externally.

Material: 316 stainless steel.

Ring Seal: EPDM x1 supplied.

Product No	D1	Flange	D3	L1	X1	t	PCD	ØB
IPS.575.15E*	1/2"	Table E	95	47	26	6	67	14 x4
IPS.575.20E*	3/4"	Table E	100	52	28	6	73	14 x4
IPS.575.25E*	1"	Table E	115	56	30	7	83	14 x4
IPS.575.40E*	1 1/2"	Table E	120	62	31	8	87	14 x4
IPS.575.50E*	2"	Table E	150	89	44	10	114	18 x4

IPS Cap End Socket End

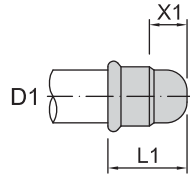
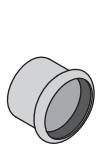

Material: 316 stainless steel.

Ring Seal: EPDM x1 supplied.

Product No	D1	L1	X1
IPS.332.15	1/2"	39.6	18.3
IPS.332.20	3/4"	44.2	20.1
IPS.332.25	1"	47.0	21.1
IPS.332.40	1 1/2"	54.6	24.1
IPS.332.50	2"	73.9	29.0

IPS Roll Groove Adaptor

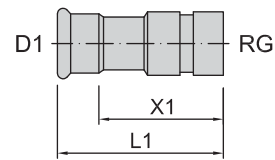
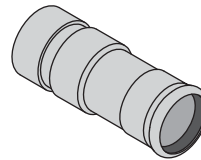

Material: 316 stainless steel.

Ring Seal: EPDM x1 supplied.

Product No	D1	RG	L1	X1
IPS.374.15*	1/2"	1/2"	84	64
IPS.374.20*	3/4"	3/4"	86	65
IPS.374.25*	1"	1"	89	66
IPS.374.40*	1 1/2"	1 1/2"	105	75
IPS.374.50*	2"	2"	116	81

Note: * This product available on request.

Ball Valve 2 Piece FI BSP

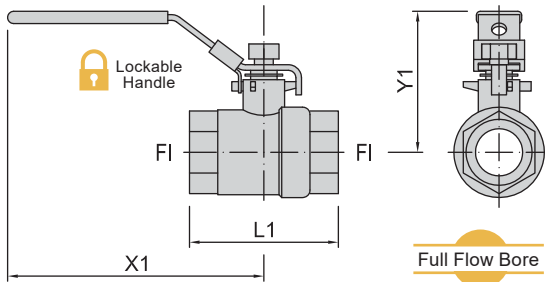

Body: CF8M stainless steel (cast version of 316).
 Ball, Stem & Lever: 316 stainless steel.
 Seat: Teflon (PTFE).
 Handle Colour: blue.
 Working Temp: -20 to 180°C.
 Cold Working Pressure: 6,895kPa (69 bar or 1,000psi).

Product No	FI BSP	L1	X1	Y1
316.BV2.006	1/4"	48	100	48
316.BV2.010	3/8"	48	100	48
316.BV2.015	1/2"	58	100	52
316.BV2.020	3/4"	66	127	61
316.BV2.025	1"	77	127	65
316.BV2.032	1 1/4"	90	154	79
316.BV2.040	1 1/2"	98	154	83
316.BV2.050	2"	121	192	97

*Check suitability of chemicals with us before ordering or installing.
 Larger sizes are available on request.

Ball Valve 3 Piece FI BSP

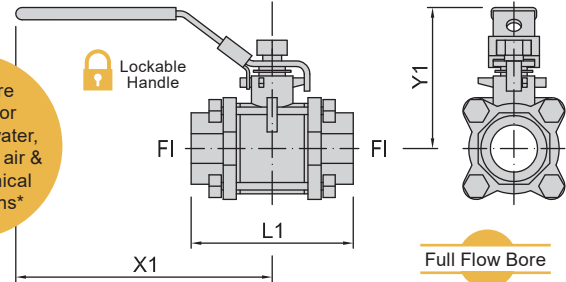

Body: CF8M stainless steel (cast version of 316).
 Ball, Stem & Lever: 316 stainless steel.
 Seat: Teflon (PTFE).
 Handle Colour: blue.
 Working Temp: -20 to 180°C.
 Cold Working Pressure: 6,895kPa (69 bar or 1,000psi).

Product No	FI BSP	L1	X1	Y1
316.BV3.006	1/4"	50	100	48
316.BV3.010	3/8"	50	100	48
316.BV3.015	1/2"	64	100	52
316.BV3.020	3/4"	71	127	61
316.BV3.025	1"	81	127	65
316.BV3.032	1 1/4"	94	154	79
316.BV3.040	1 1/2"	104	154	83
316.BV3.050	2"	127	192	97

*Check suitability of chemicals with us before ordering or installing.
 Larger sizes are available on request.



AusPress® Press-Fit

IPS 316